

1/8"

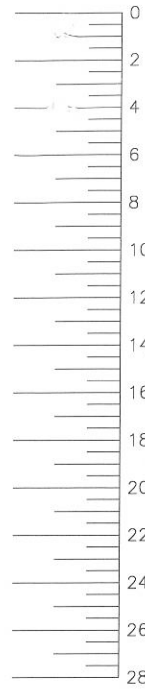

3/16"

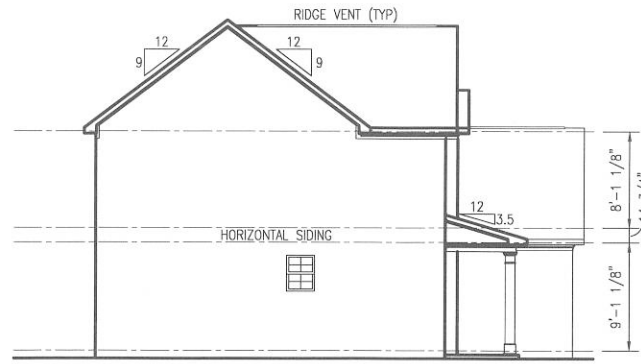
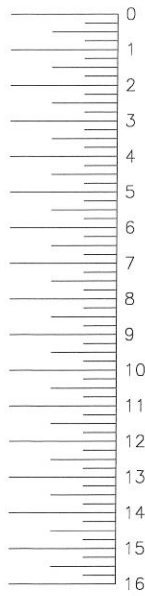

LEFT ELEVATION

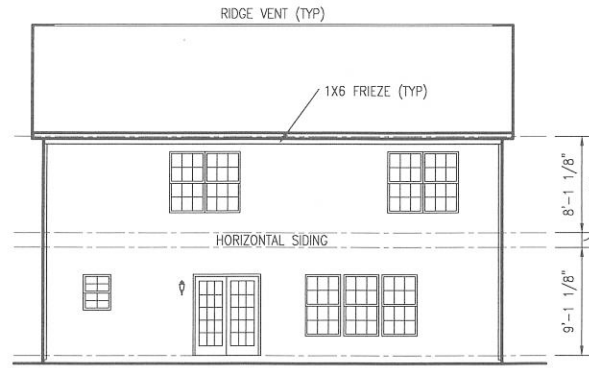

REAR ELEVATION

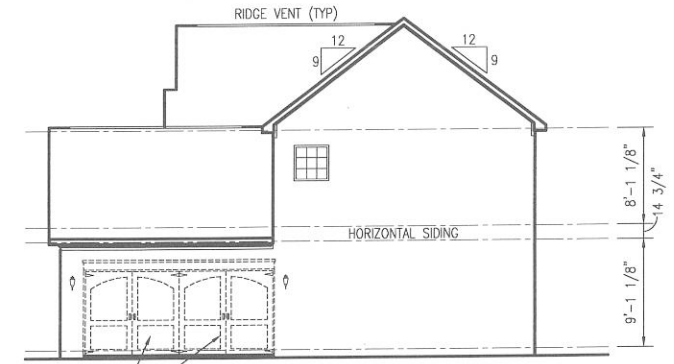

RIGHT ELEVATION

SIDE ENTRY GARAGE OPTION
A117851, 1x8 W/BRICK MLD.
CAP OVER GARAGE DOOR

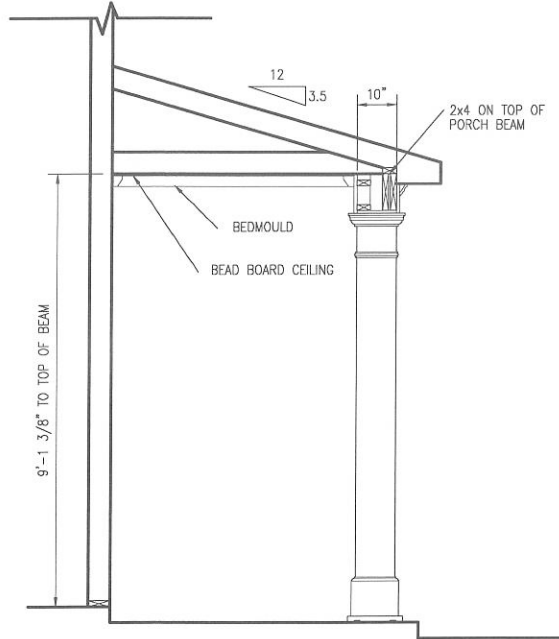

SECTION @ PORCH COLUMN

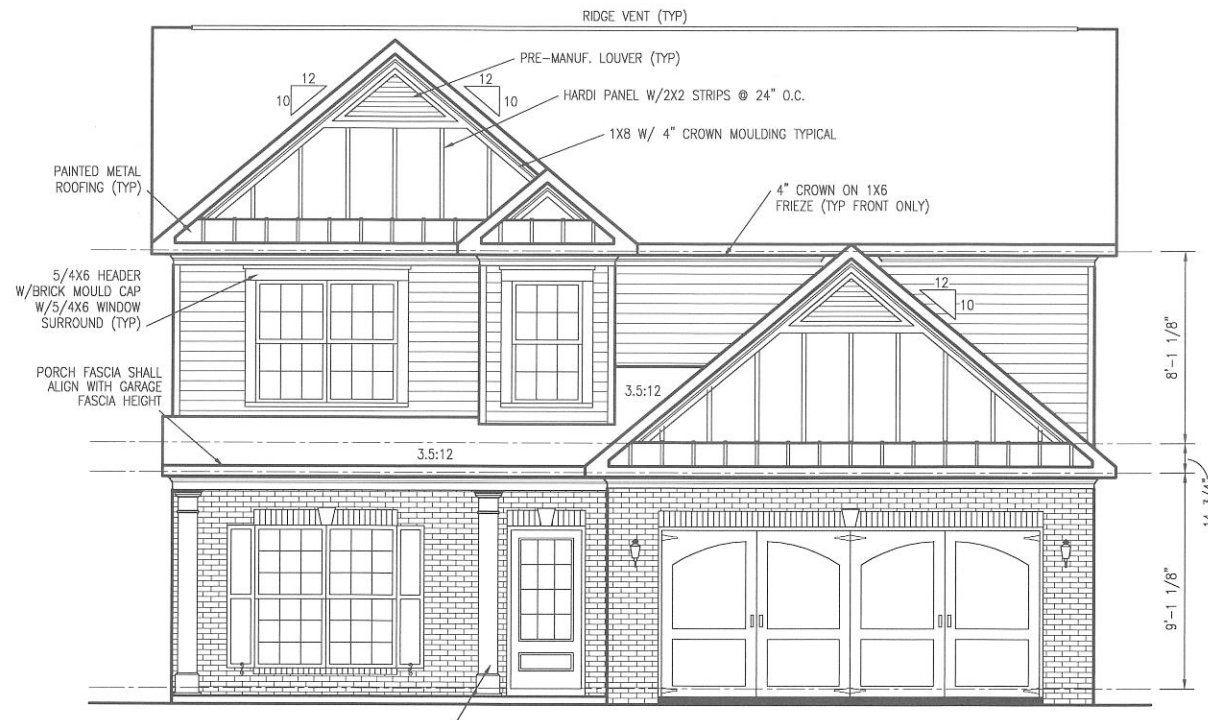

FRONT ELEVATION

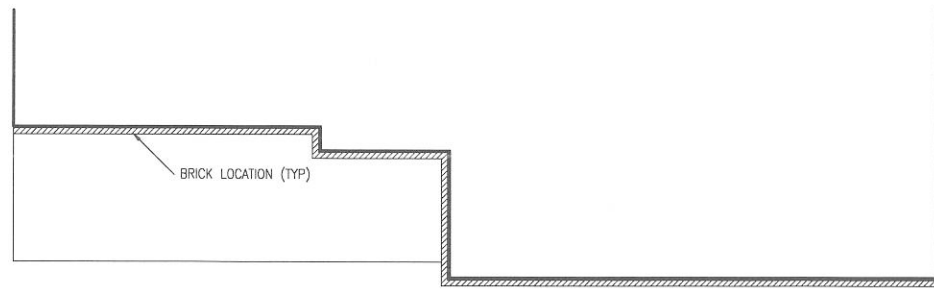

STONE LOCATIONS

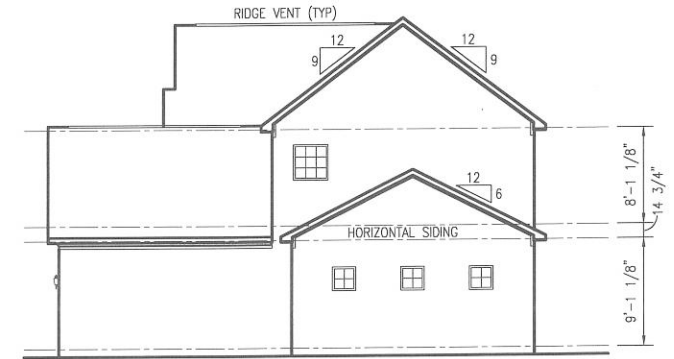

**RIGHT ELEVATION
W/ TANDEM GARAGE OPTION A114034**

NOT AVAILABLE WITH SIDE ENTRY GARAGE OPTION A117851



TANDEM GARAGE OPTION A114034

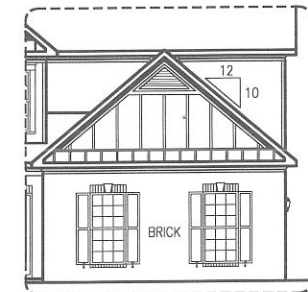

SIDE ENTRY OPTION A117851

- INSTALL ALL EXTERIOR LIGHTING @ 6'-0" AFF TO CENTERLINE OF FIXTURE
- REFER TO ROOF PLAN FOR GUTTER AND DOWNSPOUT LOCATIONS

REVISION NUMBER ~ REFER TO COVER SHEET FOR DESCRIPTION

DRAWING SCALE:
VARIES

RELEASE DATE	SET NUMBER	OPTION NO.

MODEL
HAWTHORNE "B"
DRAWING TITLE
EXTERIOR ELEVATIONS
OPTION DESCRIPTION

SHEET NO.

A1.1B

SEQUENCE NO. **B1**