

1/8"

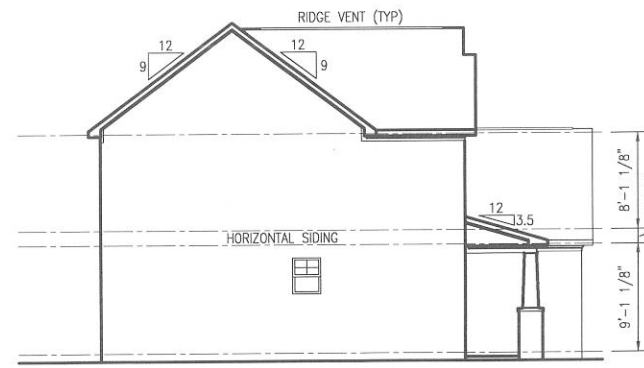

3/16"

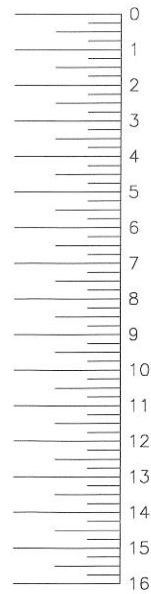

**LEFT ELEVATION**

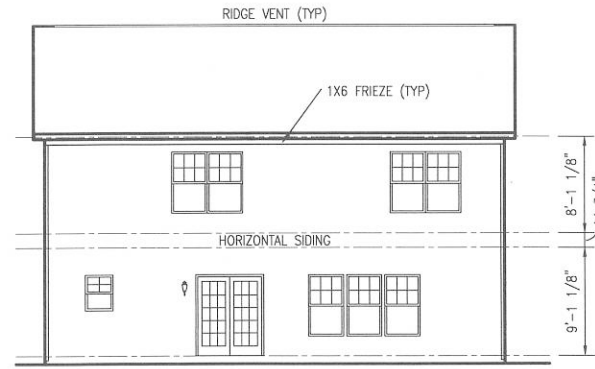

**REAR ELEVATION**

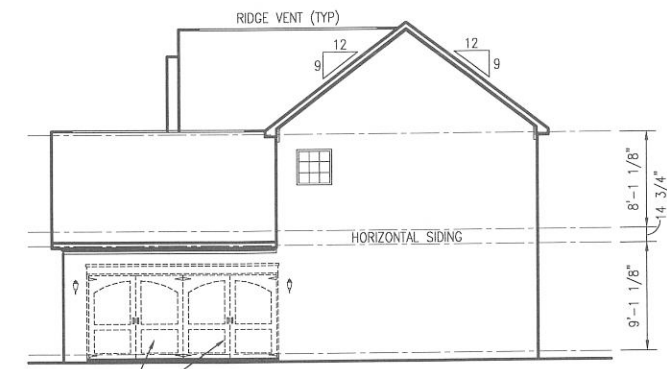

**RIGHT ELEVATION**

SIDE ENTRY GARAGE OPTION  
A117851, 1x8 W/BRICK MLD.  
CAP OVER GARAGE DOOR

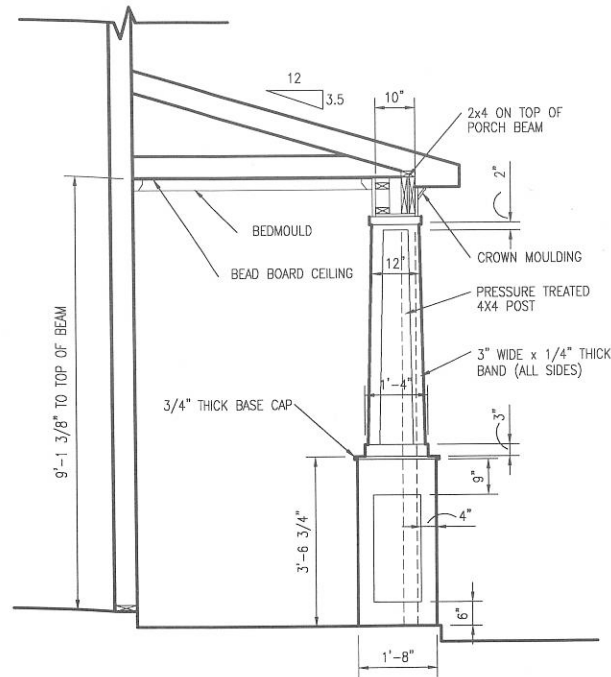

**SECTION @ PORCH COLUMN**



**FRONT ELEVATION**

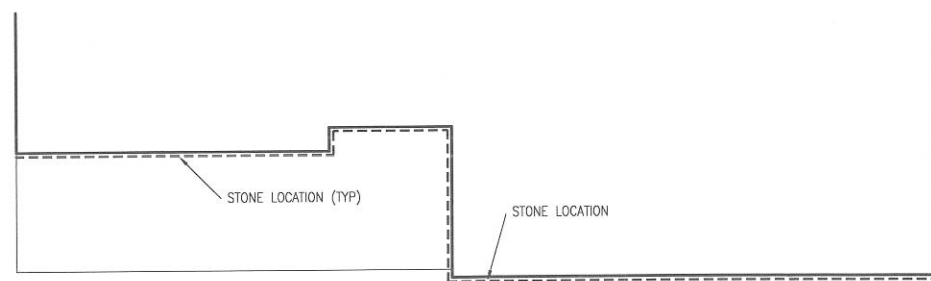

**STONE LOCATIONS**

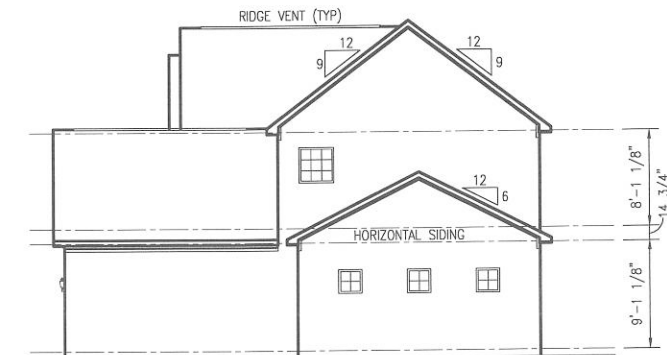

**RIGHT ELEVATION  
W/ TANDEM GARAGE OPTION A114034**

NOT AVAILABLE WITH SIDE ENTRY GARAGE OPTION A117851



**TANDEM GARAGE OPTION A114034**

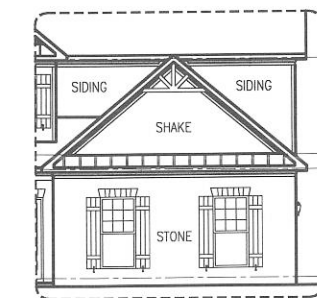

**SIDE ENTRY OPTION A117851**

- INSTALL ALL EXTERIOR LIGHTING @ 6"-0" AFF TO CENTERLINE OF FIXTURE
- REFER TO ROOF PLAN FOR GUTTER AND DOWNSPOUT LOCATIONS

REVISION NUMBER ~ REFER TO COVER SHEET FOR DESCRIPTION

DRAWING SCALE:  
**VARIES**

RELEASE DATE	SET NUMBER	OPTION NO.

MODEL  
**HAWTHORNE "A"**

DRAWING TITLE  
**EXTERIOR ELEVATIONS**

OPTION DESCRIPTION

SHEET NO.

**A1.1A**

SEQUENCE NO. **A1**